

halco



**KUNSTGESCHMIEDETE
MÖBEL-
BESCHLAGE
WROUGHT IRON
FURNITURE
FITTINGS**

Schmiedeeisen hat eine alte Tradition. Die Geschichte der europäischen Schmiedekunst umfaßt ca. 1000 Jahre. Um auch heute noch existieren zu können, müssen geschmiedete Beschläge zwei sehr unterschiedliche Aufgaben in einer besonderen Weise miteinander kombinieren können. Das ist zum Einen der technisch-funktionelle Bereich, und zum Anderen der dekorative Bereich.

Die optimale Funktion, der Schutz vor Beschädigung, sowie die schnelle und präzise Montage der Beschlägeteile müssen als Grundbedingung gewährleistet werden.

Seine Besonderheit findet der schmiedeeiserne Beschlag durch die dekorative Gestaltung - es ermöglicht den freien Lauf schöpferischer Phantasie, abseits der strengen Norm einzig funktionell gestalteter Teile.

Die Stärke geschmiedeter Beschläge liegt neben dem praktischen Wert in der Funktion, das schmückende Element in besonderer Weise hervorzuheben.

Erst die Vielfalt von angebotenen Formen erlaubt die Zuordnung der einzelnen Beschläge an jeweilige Objekte.

Farbe und Oberfläche sind mit das entscheidende Kriterium an einem hochwertigen Zierbeschlag.

In jahrelanger Erprobung wurde im eigenen Haus ein längst in Vergessenheit geratenes Verfahren mit den heute zur Verfügung stehenden Möglichkeiten der Technik kombiniert und damit Werte erreicht, die bisherige Methoden um ein Vielfaches übertreffen.

Die Besonderheit des Oberflächenaussehens wurde in idealer Weise mit der Schutzfunktion vereint, und gewährleistet, daß die Elemente auch nach jahrelanger Verwendung ihr dekoratives Aussehen nicht verlieren.

Die Natürlichkeit der Formgebung und Oberflächengestaltung hebt schmiedeeiserne Beschläge von den nüchtern funktionellen und kalten Formen des Materials ab, dem jeder von uns täglich begegnet.

Wrought iron is an old art, dating back about one thousand years in Europe.

Even today, if they are to be successful, wrought iron fittings must offer a special combination of two distinct tasks, namely the technical or functional aspect on the one hand and the decorative aspect on the other. Above all they must fulfil their protective function one hundred percent while offering both speed and accuracy of fitting at the same time.

The special feature of wrought iron fittings is the decorative value of their design, which gives unlimited scope to the craftsman's imagination, something that can never be achieved with the strict requirements of purely functional pieces. Apart from the practical advantages the big attraction of wrought iron fittings lies in their ability to focus on the decorative function. And it is the sheer variety of forms available that permits the ideal choice of fitting to be made for the respective object.

Colour and surface finish are among the decisive criteria for a decorative fitting of the highest standard.

After years of experiment we have succeeded in combining a long-forgotten technique with modern technology, and the results are far superior to those achieved using conventional methods.

The special character of the surface finish harmonises exquisitely with the protective function of the fittings and guarantees that, even after many years of use, the fittings retain their attractive appearance.

The natural designs and surface finish distinguish wrought iron fittings from the cold and sober functional forms of the material with which we are all confronted every day.

Inhaltsangabe	Seite
Contents	Page
Möbelbeschläge Modell Tirol S 300 Furniture fittings model Tirol S 300	4 - 9
Möbelbeschläge Modell Stubai S 350 Furniture fittings model Stubai S 350	10, 11
Möbelbeschläge Modell Kärnten S 400 Furniture fittings model Kärnten S 400	12, 13
Möbelbeschläge Modell Wien S 500 Furniture fittings model Wien S 500	14 - 17
Möbelbeschläge Modell Osttirol S 550 Furniture fittings model Osttirol S 550	18, 19
Möbelbeschläge Modell Salzburg S 600 Furniture fittings model Salzburg S 600	20, 21
Möbelbeschläge Modell Rustikal S 900 Furniture fittings model Rustikal S 900	22 - 29
Rosetten Escutcheons	30, 31
Hut- und Mantelhaken Hat and coat hooks	32 - 35
Schrägarne, Klapphaken, Träger Coat hooks, folding hook, carriers	36, 37
Zierhülsen, Möbelschloß Decorative sleeves, furniture lock	38, 39
Ziernägel, geschmiedet Ornamental nails forged	40, 41
Ziernägel Zink - Druckguß Ornamental nails die-casting zinc	42, 43
Zubehörteile Accessories	44

Modell Tirol S 300

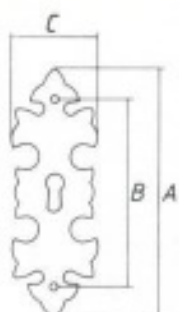

8788 Schlüsselschild - hoch Key plate - upright

Art.-Nr.	Maße in mm						
	☉☉☉	A	B	C	↗	↘	⊞
8788.01	40	97	75	36	2	3x15	20
8788.02	50	115	84	43	2	3x15	20
8788.03	65	130	105	46	2	3x15	20

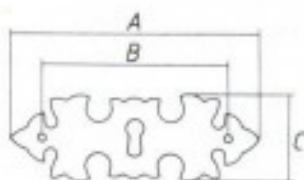

8790 Schlüsselschild - quer Key plate - horizontal

Art.-Nr.	Maße in mm						
	☉☉☉	A	B	C	↗	↘	⊞
8790.01	40	97	75	36	2	3x15	20
8790.02	50	115	84	43	2	3x15	20
8790.03	65	130	105	46	2	3x15	20

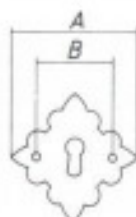

8792 Schlüsselschild Key plate

Art.-Nr.	Maße in mm						
	☉☉☉	A	B	↗	↘	⊞	
8792.01	25	50	28	2	3x15	20	

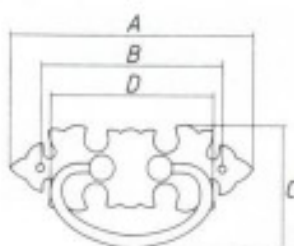

8794 Möbelgriff Furniture handle

Art.-Nr.	Maße in mm							
	☉☉☉	A	B	C	D	↗	↘	⊞
8794.01	60	97	75	50	65	2	3x15	20
8794.02	90	115	84	60	75	2	3x15	20
8794.03	100	130	105	65	90	2	3x15	20

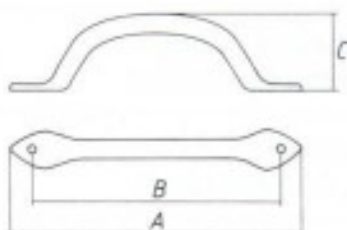

8796 Möbelgriff - feststehend Furniture handle - rigid

Art.-Nr.	Maße in mm						
	☉☉☉	A	B	C	↗	↘	⊞
8796.01	70	135	115	30	7	4x20	20
8796.02	140	180	150	52	9	4x20	20

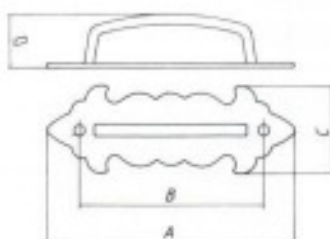

8602 Möbelgriff - feststehend Furniture handle - rigid

Art.-Nr.	Maße in mm							
	☉☉☉	A	B	C	D	↗	↘	⊞
8602.01	40	100	74	25	63	2	3,5x20	20
8602.02	70	128	94	27	77	2	3,5x20	20

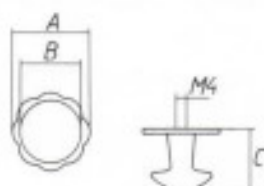

8606 Möbelknopf Drawer knob

Art.-Nr.	Maße in mm						
	☉☉☉	A	B	C	↗	↘	⊞
8606.01	60	30	25	30	2	4x30	20

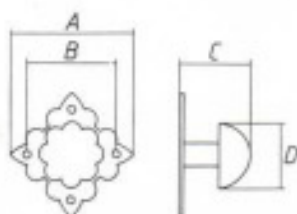

8607 Möbelknopf Furniture knob

Art.-Nr.	Maße in mm							
	☉☉☉	A	B	C	D	↗	↘	⊞
8607.01	50	50	36	28	25	2	3x15	20
8607.02	80	61	—	35	27	2	4x30	20



Modell Tirol S 300

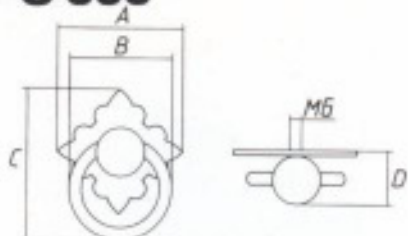

8610 Ringgriff Ring handle

Art.-Nr.	Maße in mm						↔	↗	↘
	A	B	C	D	↔	↗			
8610.01	75	50	47	63	21	M6x30	20		

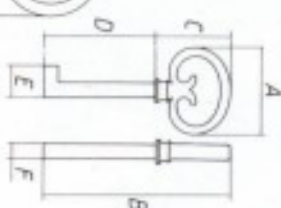

8612 Möbelschlüssel Furniture key

Art.-Nr.	Maße in mm						↔	↗	↘
	A	B	C	D	E	F			
8612.01	30	34	75	30	45	13,5	6	20	

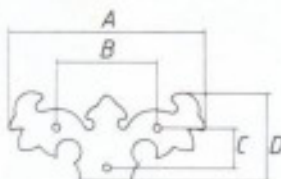

8786 Scheinband Hinge shield

Art.-Nr.	Maße in mm						↔	↗	↘
	A	B	C	D	↔	↗			
8786.01	20	78	44	16	36	1,5	3x15	20	
8786.02	35	100	55	22	46	2	3x15	20	
8786.03	45	120	70	28	52	2	3x15	20	
8786.04	75	145	79	34	63	2	3x15	20	

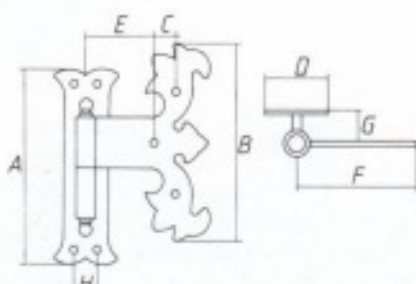

8780 Möbelband mit Aufschraubkegel Hinge shield with plate

Art.-Nr.	Maße in mm									↔	↗	↘
	A	B	C	D	E	F	G	H	↔			
8780.01	80	77	80	8	25	26	48	12	9	2	3x15	20
8780.02	95	77	100	6	25	37	60	12	9	2	3,5x20	20
8780.03	140	98	123	10	33	43	71	15	14	2	3,5x20	20

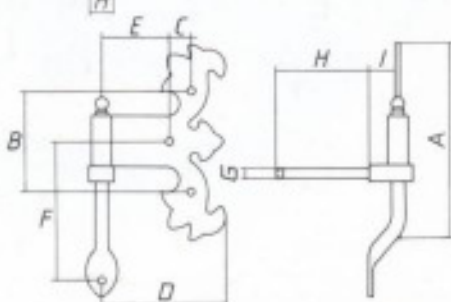

8782 Möbelband mit Stützkegel Hinge shield with support pin

Art.-Nr.	Maße in mm											↔	↗	↘
	A	B	C	D	E	F	G	H	I	↔	↗			
8782.01	55	80	44	8	48	26	52	M4	40	12	2	3x15	20	
8782.02	70	100	55	6	60	37	51	M4	40	12	2	3,5x20	20	
8782.03	90	123	70	10	71	43	49	M4	40	12	2	3,5x20	20	

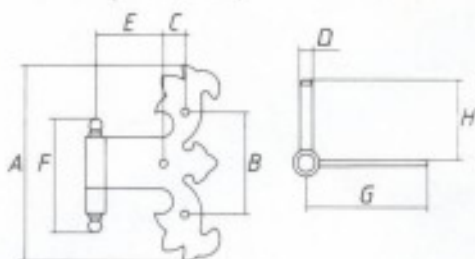

8784 Möbelband mit Einbohrkegel Hinge shield with bolt hole

Art.-Nr.	Maße in mm									↔	↗	↘
	A	B	C	D	E	F	G	H	↔			
8784.01	55	80	44	16	56x0,9	26	46	48	31	2	3x15	20
8784.02	70	100	55	22	56x0,9	37	50	60	31	2	3,5x20	20
8784.03	90	123	70	28	56x0,9	43	55	71	31	2	3,5x20	20

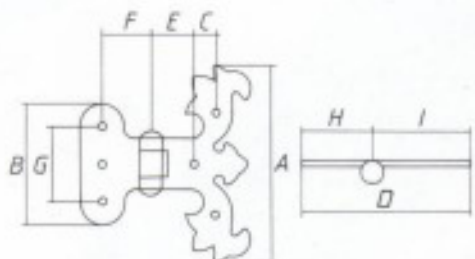

8783 Scharnierband - gerade Hinge frame - straight

Art.-Nr.	Maße in mm											↔	↗	↘
	A	B	C	D	E	F	G	H	I	↔	↗			
8783.01	50	80	50	8	66	26	19	34	27	39	1,5	3x15	20	
8783.02	65	100	68	6	78	37	25	48	35	43	1,5	3,5x20	20	
8783.03	80	123	80	10	91	43	26	56	39	52	1,5	3,5x20	20	

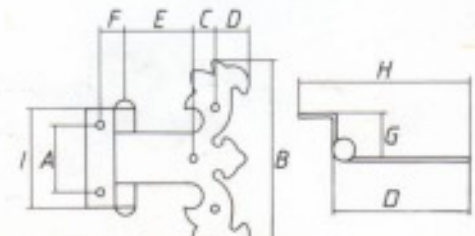

8785 Scharnierband - gekröpft Hinge frame - offset

Art.-Nr.	Maße in mm											↔	↗	↘
	A	B	C	D	E	F	G	H	I	↔	↗			
8785.01	50	30	80	8	53	28	12	18	65	40	1,5	3x15	20	
8785.02	65	30	100	6	63	38	12	18	75	40	1,5	3,5x20	20	
8785.03	80	40	123	10	76	45	15	18	93	50	1,5	3,5x20	20	



Modell Tirol S 300

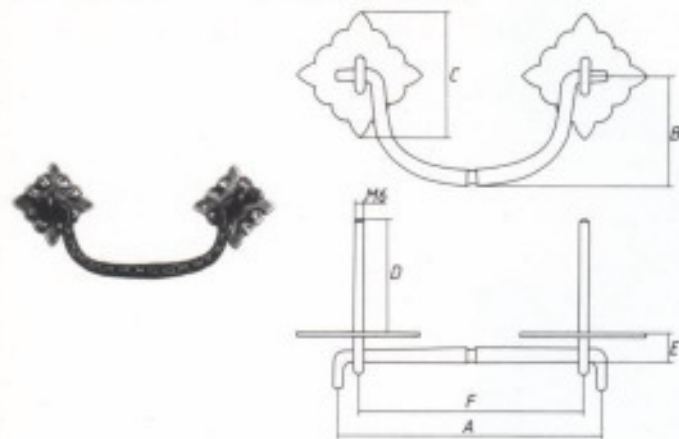

8613 Truhengriff
Chest handle

Art.-Nr.	Maße in mm									
	A	B	C	D	E	F	↖	↗	⊞	
8613.01	200	135	57	66	62	16	118	2	M6	10
8613.02	260	160	57	66	62	16	140	2	M6	10

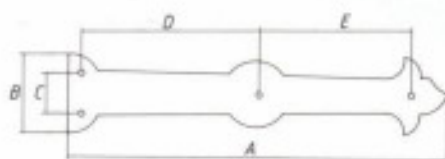

8662 Scheinband
Hinge shield

Art.-Nr.	Maße in mm								
	A	B	C	D	E	↖	↗	⊞	
8662.01	75	203	41	21	94	81	2	3x15	10
8662.02	225	304	42	21	97	118	3	3x15	10

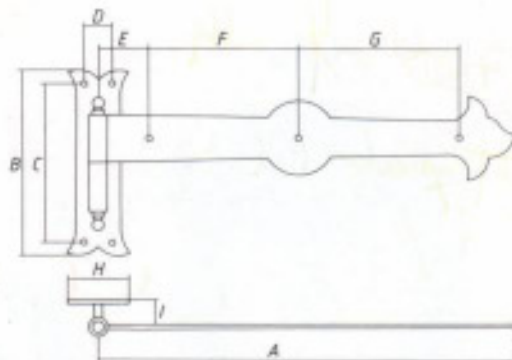

8669 Langband mit Kegel
Hinge

Art.-Nr.	Maße in mm												
	A	B	C	D	E	F	G	H	I	↖	↗	⊞	
8669.01	160	223	99	85	13	28	81	85	32	16	2	3x20	10
8669.02	375	300	99	85	13	28	97	118	32	16	3	4x20	10

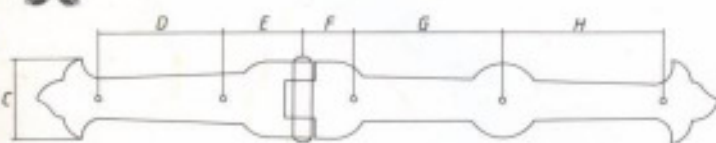

8615 Truhenband
Chest hinge

Art.-Nr.	Maße in mm											
	A	B	C	D	E	F	G	H	↖	↗	⊞	
8615.01	180	142	220	43	70	41	25	81	85	2	3,5x20	10
8615.02	360	128	297	43	72	24	49	97	118	3	4x20	10

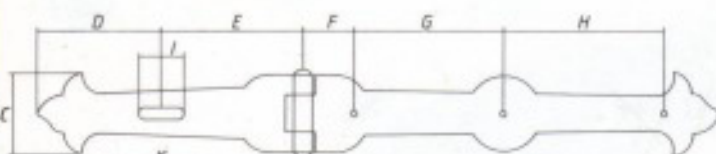

8614 Überfalle mit Schlaufe
Chest hinge

Art.-Nr.	Maße in mm														
	A	B	C	D	E	F	G	H	I	K	L	↖	↗	⊞	
8614.01	210	142	220	43	65	77	25	81	85	29	46	27	2	3,5x20	10
8614.02	390	128	297	43	67	61	49	97	118	29	46	27	3	4x20	10

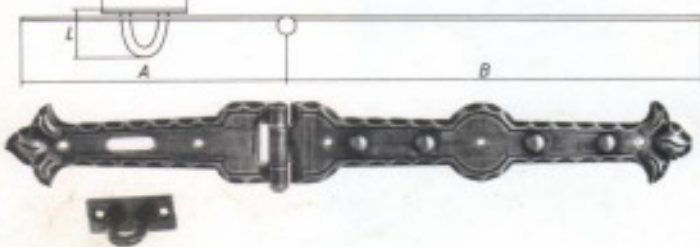



Modell Stubai S 350

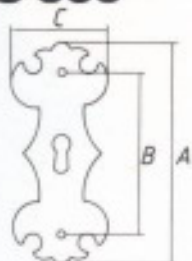

8617 Schlüsselschild - hoch Key plate - upright

Art.-Nr.	Maße in mm						
	A	B	C	↗	↘	⊗	
8617.01	15	73	41	32	1,5	3x15	20
8617.02	30	85	62	36	2	3x15	20
8617.03	55	110	84	52	2	3x15	20

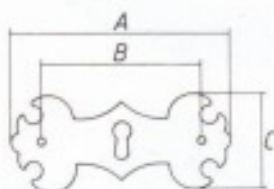

8616 Schlüsselschild - quer Key plate - horizontal

Art.-Nr.	Maße in mm						
	A	B	C	↗	↘	⊗	
8616.01	15	73	41	32	1,5	3x15	20
8616.02	30	85	62	36	2	3x15	20
8616.03	55	110	84	52	2	3x15	20

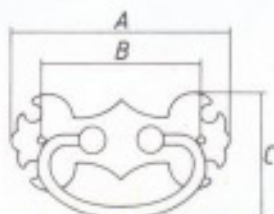

8600 Möbelgriff Furniture handle

Art.-Nr.	Maße in mm						
	A	B	C	↗	↘	⊗	
8600.01	55	85	62	50	2	3x15	20
8600.02	95	110	84	65	2	3x15	20

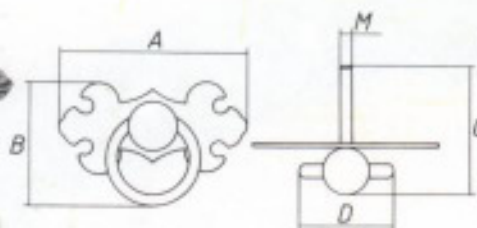

8604 Ringgriff Furniture handle

Art.-Nr.	Maße in mm							
	A	B	C	D	↗	↘	⊗	
8604.01	65	73	55	49	42	1,5	M6x30	20

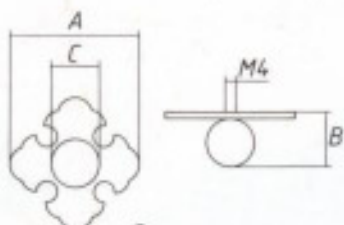

8812 Möbelknopf Furniture knob

Art.-Nr.	Maße in mm						
	A	B	C	↗	↘	⊗	
8812.01	25	51	40	20	1,5	M4x30	20
8812.02	130	51	54	32	1,5	M4x30	20

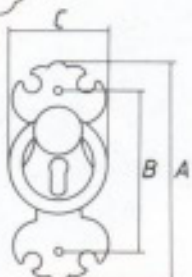

8605 Ringgriff mit fester Platte Ring handle with escutcheon

Art.-Nr.	Maße in mm						
	A	B	C	↗	↘	⊗	
8605.01	65	85	62	42	2	3x15	20
8605.02	90	110	84	42	2	3x15	20

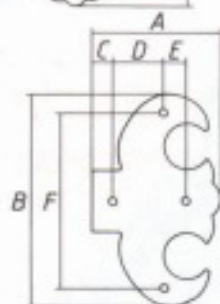

8622 Scheinband Hinge shield

Art.-Nr.	Maße in mm									
	A	B	C	D	E	F	↗	↘	⊗	
8622.01	20	41	70	6	17	6	59	1,5	3x15	20
8622.02	30	51	85	9	20	7	70	1,5	3x15	20
8622.03	60	63	104	14	21	11	87	1,5	3x15	20

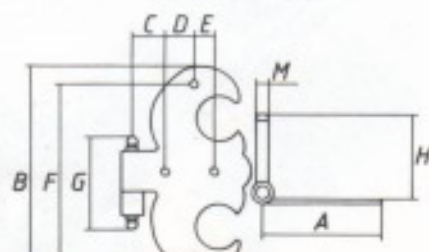

8625 Möbelband mit Einbohrkegel Hinge shield with bolt hole

Art.-Nr.	Maße in mm												
	A	B	C	D	E	F	G	H	↗	↘	M	⊗	
8625.01	35	45	70	14	17	6	59	37	37	1,5	3x15	S6x0,9	20
8625.02	45	50	85	14	20	7	70	37	37	1,5	3x15	S6x0,9	20
8625.03	60	60	104	18	21	11	87	41	37	1,5	3x15	S6x0,9	20



Modell Kärnten S 400

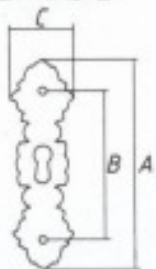

8618 Schlüsselschild - hoch Key plate - upright

Art.-Nr.	Maße in mm						
	A	B	C	≠	→	⊗	
8618.01	15	80	50	25	1,5	3x15	20
8618.02	40	112	76	40	1,5	3x15	20

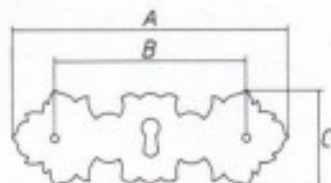

8618 Schlüsselschild - quer Key plate - horizontal

Art.-Nr.	Maße in mm						
	A	B	C	≠	→	⊗	
8618.51	15	80	50	25	1,5	3x15	20
8618.52	40	112	76	40	1,5	3x15	20

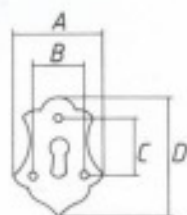

8620 Schlüsselschild Key plate

Art.-Nr.	Maße in mm							
	A	B	C	D	≠	→	⊗	
8620.01	10	33	20	22	44	2	3x15	20

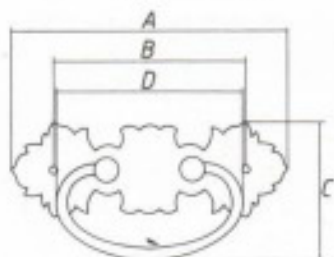

8601 Möbelgriff Furniture handle

Art.-Nr.	Maße in mm							
	A	B	C	D	≠	→	⊗	
8601.01	45	80	62	25	65	1,5	3x15	20
8601.02	75	112	77	38	85	1,5	3x15	20

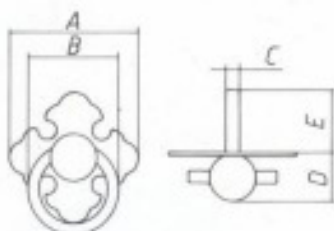

8609 Ringgriff Ring handle

Art.-Nr.	Maße in mm							
	A	B	C	D	E	F	⊗	
8609.01	60	51	42	M6	20	28	1,5	20



8612 Möbelschlüssel Furniture key

Art.-Nr.	Maße in mm							
	A	B	C	D	E	F	⊗	
8612.01	30	34	75	30	45	13,5	6	20

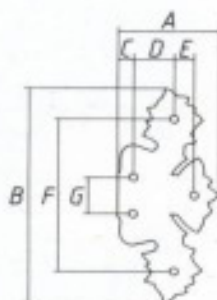

8623 Scheinband Hinge shield

Art.-Nr.	Maße in mm										
	A	B	C	D	E	F	G	≠	→	⊗	
8623.01	15	34	66	7	15	7	45	12	1,5	3x15	20
8623.02	20	41	84	7	15	9	60	14	1,5	3x15	20
8623.03	30	65	94	8	28	17	72	21	1,5	3x15	20

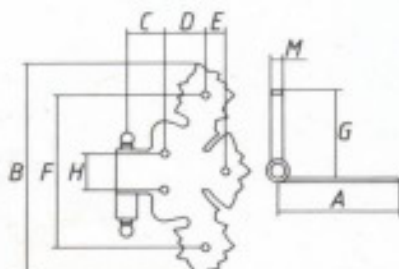

8626 Möbelband mit Einbohrkegel Hinge shield with bolt hole

Art.-Nr.	Maße in mm												
	A	B	C	D	E	F	G	H	≠	→	M	⊗	
8626.01	35	45	66	16	15	7	45	35	12	1,5	3x15	S6x0,9	20
8626.02	45	50	84	16	15	9	60	35	14	1,5	3x15	S6x0,9	20
8626.03	65	75	94	17	28	17	72	35	21	1,5	3x15	S6x0,9	20



Modell Wien S 500

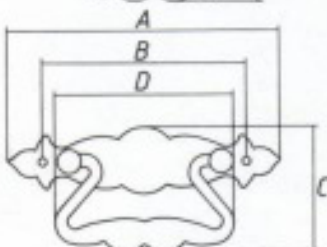
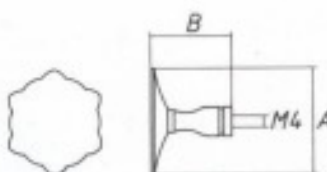
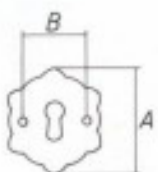
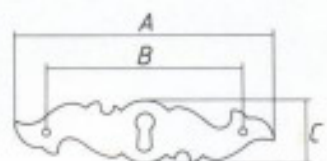
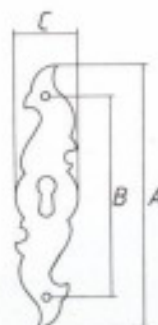
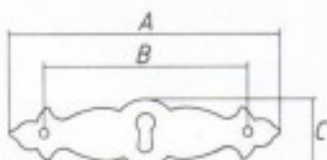
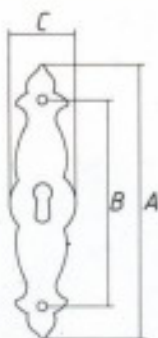

8758 Schlüsselschild - hoch Key plate - upright

Art.-Nr.	Maße in mm					
	A	B	C	Ø	Ø	Ø
8758.01	25	104	78	25	2	3x15 20
8758.02	35	125	88	28	2	3x15 20

8760 Schlüsselschild - quer Key plate - horizontal

Art.-Nr.	Maße in mm					
	A	B	C	Ø	Ø	Ø
8760.01	25	104	78	25	2	3x15 20
8760.02	35	125	88	28	2	3x15 20

8762 Schlüsselschild - hoch Key plate - upright

Art.-Nr.	Maße in mm					
	A	B	C	Ø	Ø	Ø
8762.01	25	99	75	25	2	3x15 20
8762.02	30	121	91	29	2	3x15 20

8764 Schlüsselschild - quer Key plate - horizontal

Art.-Nr.	Maße in mm					
	A	B	C	Ø	Ø	Ø
8764.01	25	99	75	25	2	3x15 20
8764.02	30	121	91	29	2	3x15 20

8766 Schlüsselschild Key plate

Art.-Nr.	Maße in mm					
	A	B	Ø	Ø	Ø	
8766.01	15	41	25	2	3x15 20	

8774 Möbelknopf Furniture knob

Art.-Nr.	Maße in mm					
	A	B	Ø	Ø	Ø	
8774.01	25	32	30	2	M 4x30 20	
8774.02	30	40	30	2	M 4x30 20	

8772 Ringgriff Ring handle

Art.-Nr.	Maße in mm					
	A	B	C	Ø	Ø	Ø
8772.01	45	50	25	63	2	M 4x30 20

8768 Möbelgriff Furniture knob

Art.-Nr.	Maße in mm					
	A	B	C	D	Ø	Ø
8768.01	60	104	78	46	70	2 3x15 20
8768.02	75	125	88	61	68	2 3x15 20

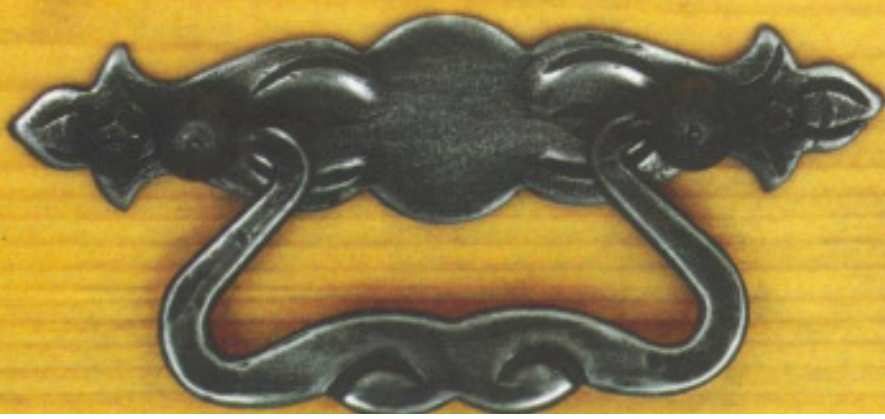

Modell Wien S 500

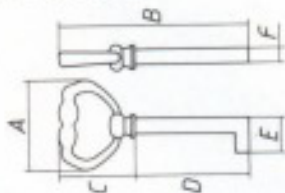

8771 Möbelschlüssel Furniture key

Art.-Nr.	Maße in mm							⊕	⊖	⊗
	A	B	C	D	E	F				
8771.01	30	34	75	30	45	13,5	6	20		

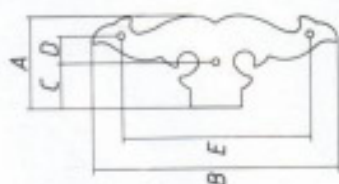

8756 Scheinband Hinge shield

Art.-Nr.	Maße in mm							⊕	⊖	⊗
	A	B	C	D	E	F				
8756.01	25	37	97	15	10	75	2	3x15	20	
8756.02	35	43	120	18	11	91	2	3x15	20	

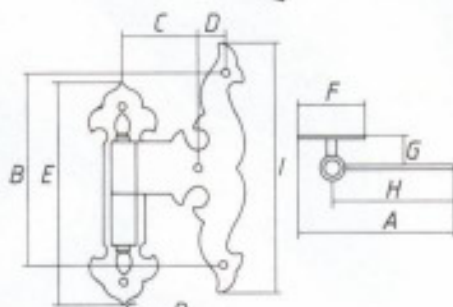

8750 Möbelband mit Aufschraubkegel Hinge shield with plate

Art.-Nr.	Maße in mm										⊕	⊖	⊗	
	A	B	C	D	E	F	G	H	I	M				
8750.01	85	63	75	30	10	86	27	12	49	97	2	3x15	20	
8750.02	90	68	91	31	11	86	27	12	54	12	2	3x15	20	

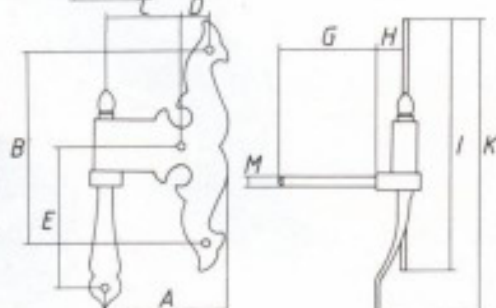

8752 Möbelband mit Stützkegel Hinge shield with support pin

Art.-Nr.	Maße in mm												⊕	⊖	⊗
	A	B	C	D	E	G	H	I	K	M	N				
8752.01	65	49	75	30	10	56	37	11	97	115	M4	2	3x15	20	
8752.02	70	54	91	31	11	57	37	11	120	125	M4	2	3x15	20	

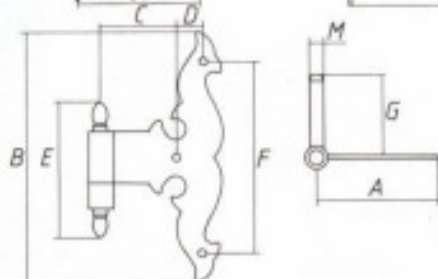

8753 Möbelband mit Einbohrkegel Hinge shield with bolt hole

Art.-Nr.	Maße in mm										⊕	⊖	⊗	
	A	B	C	D	E	F	G	M	N					
8753.01	55	49	97	30	10	52	75	28	2	3x15	56x0,9	20		
8753.02	65	54	120	31	11	56	91	28	2	3x15	56x0,9	20		

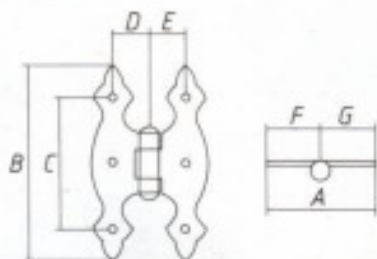

8755 Scharnierband - gerade Hinge frame - straight

Art.-Nr.	Maße in mm								⊕	⊖	⊗	
	A	B	C	D	E	F	G	H				
8755.01	35	42	76	51	13	13	21	21	1,5	3x15	20	
8755.02	50	54	97	67	16	15	27	27	1,5	3x15	20	
8755.03	65	64	112	72	19	19	32	32	1,5	3x15	20	

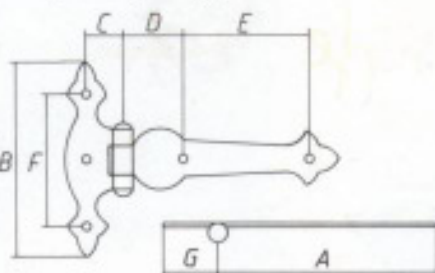

8757 Scharnierband - gerade Hinge frame - straight

Art.-Nr.	Maße in mm								⊕	⊖	⊗	
	A	B	C	D	E	F	G	H				
8757.01	35	85	67	13	22	51	51	21	1,5	3x15	20	
8757.02	55	99	97	16	21	66	67	27	1,5	3x15	20	
8757.03	75	174	112	19	33	124	72	32	1,5	3x15	20	

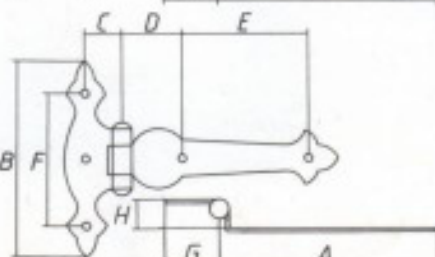

8759 Scharnierband - gekröpft Hinge frame - offset

Art.-Nr.	Maße in mm									⊕	⊖	⊗	
	A	B	C	D	E	F	G	H	I				
8759.03	75	161	112	19	20	124	72	32	12	1,5	3x15	20	



Modell Osttirol S 550

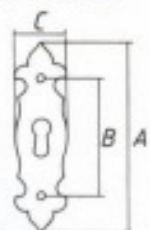

8840 Schlüsselschild Key plate

Art.-Nr.	Maße in mm						
	A	B	C	↖	↗	⊗	
8840.01	10	72	41	20	1,5	3x15	20

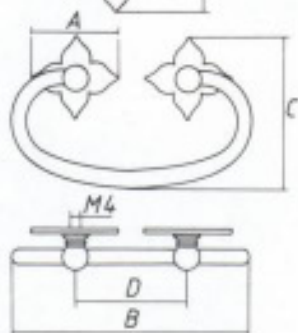

8842 Möbelgriff Furniture knob

Art.-Nr.	Maße in mm							
	A	B	C	D	↖	↗	⊗	
8842.01	75	33	90	60	45	1,5	M4x30	20

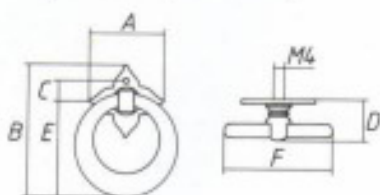

8844 Ringgriff Ring handle

Art.-Nr.	Maße in mm								
	A	B	C	D	E	↖	↗	⊗	
8844.01	25	28	45	7	18	31	1,5	M4x30	20
8844.02	35	33	49	8	18	36	1,5	M4x30	20

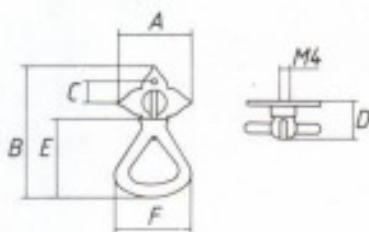

8846 Ringgriff Ring handle

Art.-Nr.	Maße in mm									
	A	B	C	D	E	F	↖	↗	⊗	
8846.01	20	28	50	7	15	31	31	1,5	M4x30	20



8848 Scheinband Hinge shield

Art.-Nr.	Maße in mm							
	A	B	C	D	↖	↗	⊗	
8848.01	15	68	52	33	1	1,5	3x15	20
8848.02	25	95	74	45	13	1,5	3x15	20

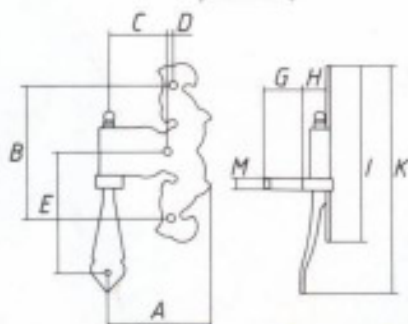

8850 Möbelband mit Stützkegel Hinge shield with support pin

Art.-Nr.	Maße in mm													
	A	B	C	D	E	G	H	I	K	M	↖	↗	⊗	
8850.01	35	39	52	23	1	48	15	13	68	90	1,5	5	3x15	20
8850.02	50	49	95	15	13	53	15	13	95	11	1,5	5	3x15	20

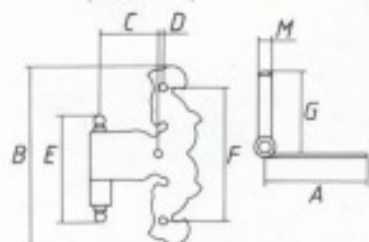

8852 Möbelband mit Einbohrkegel Hinge shield with bolt hole

Art.-Nr.	Maße in mm										
	A	B	C	D	E	F	G	↖	↗	⊗	
8852.01	30	39	68	23	1	37	52	35	1,5	3x15	20
8852.02	50	49	95	15	13	41	95	35	1,5	3x15	20

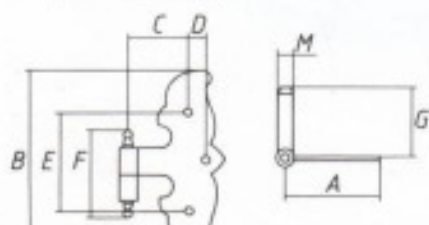

8854 Möbelband mit Einbohrkegel Hinge shield with bolt hole

Art.-Nr.	Maße in mm									
	A	B	C	D	E	F	↖	↗	⊗	
8854.01	30	68	38	34	25	38	25	1,5	3x15	20



Modell Salzburg S 600

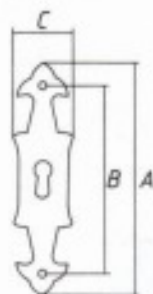

8804 Schlüsselschild - hoch Key plate - upright

Art.-Nr.	Maße in mm						
	A	B	C	↖	↗	⊞	
8804.01	20	95	78	23	2	3x15	20
8804.02	25	111	89	28	2	3x15	20

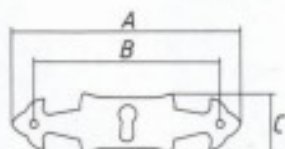

8805 Schlüsselschild - quer Key plate - horizontal

Art.-Nr.	Maße in mm						
	A	B	C	↖	↗	⊞	
8805.01	20	95	78	23	2	3x15	20
8805.02	25	111	89	28	2	3x15	20

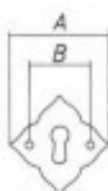

8803 Schlüsselschild Key plate

Art.-Nr.	Maße in mm					
	A	B	C	D	↖	⊞
8803.01	10	40	25	2	3x15	20
8803.02	15	50	35	2	3x15	20

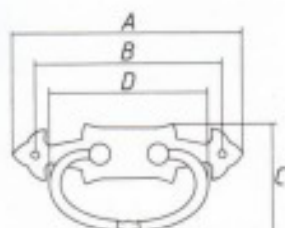

8800 Möbelgriff Furniture knob

Art.-Nr.	Maße in mm							
	A	B	C	D	↖	↗	⊞	
8800.01	50	95	78	42	62	2	3x15	20
8800.02	70	111	89	47	73	2	3x15	20

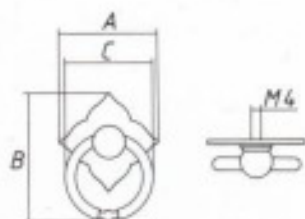

8802 Ringgriff Ring handle

Art.-Nr.	Maße in mm						
	A	B	C	↖	M	⊞	
8802.01	40	40	52	38	2	M4x30	20
8802.02	70	50	65	47	2	M4x30	20

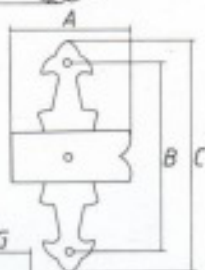

8809 Scheinband Hinge shield

Art.-Nr.	Maße in mm						
	A	B	C	↖	↗	⊞	
8809.01	20	48	78	95	2	3x15	20
8809.02	25	52	89	98	2	3x15	20

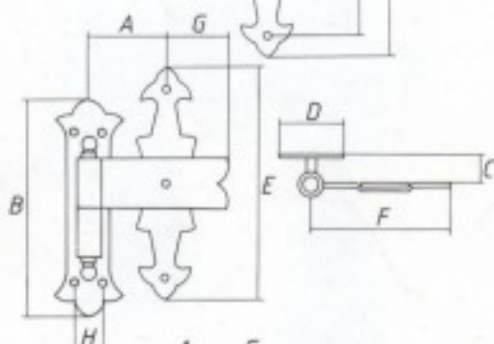

8808 Möbelband mit Aufschraubkegel Hinge shield with plate

Art.-Nr.	Maße in mm											
	A	B	C	D	E	F	G	H	↖	⊞		
8808.01	90	31	91	12	27	95	57	24	10	2	3x15	20
8808.02	105	34	91	12	27	111	66	30	10	2	3x15	20

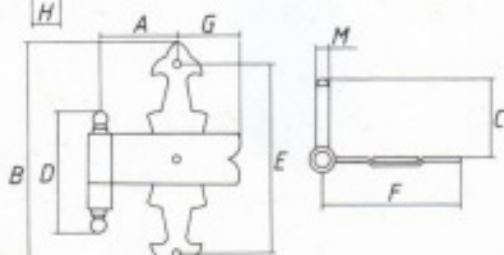
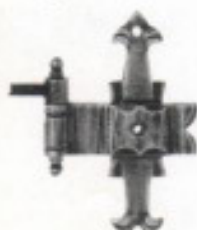

8806 Möbelband mit Einbohrkegel Hinge shield with bolt hole

Art.-Nr.	Maße in mm											
	A	B	C	D	E	F	G	↖	↗	M	⊞	
8806.01	70	31	95	32	46	78	57	32	2	3x15	S6x0,9	20
8806.02	95	34	111	32	50	89	66	32	2	3x15	S6x0,9	20

Modell Rustikal S 900

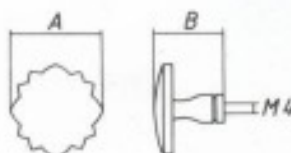
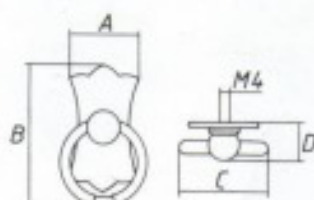
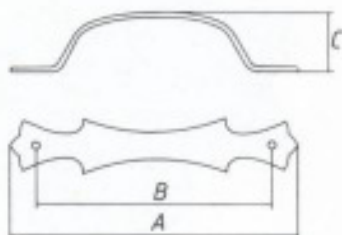
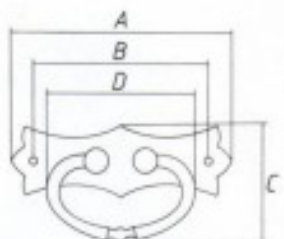
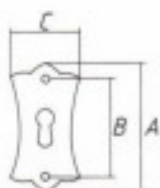
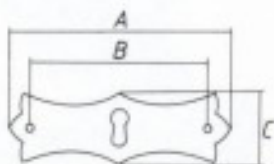

8900 Schlüsselschild - hoch Key plate - upright

Art.-Nr.	Maße in mm						
	A	B	C	Ø	Ø	Ø	
8900.01	20	77	60	24	2	3x15	20
8900.02	30	91	75	28	2	3x15	20
8900.03	40	106	90	33	2	3x15	20

8902 Schlüsselschild - quer Key plate - horizontal

Art.-Nr.	Maße in mm						
	A	B	C	Ø	Ø	Ø	
8902.02	30	91	75	28	2	3x15	20
8902.03	40	106	90	33	2	3x15	20

8904 Schlüsselschild Key plate

Art.-Nr.	Maße in mm						
	A	B	C	Ø	Ø	Ø	
8904.01	10	40	30	24	2	3x15	20
8904.02	15	51	40	29	2	3x15	20

8906 Möbelgriff Furniture knob

Art.-Nr.	Maße in mm							
	A	B	C	D	Ø	Ø	Ø	
8906.01	50	76	45	37	16	2	M4x30	20

8908 Möbelgriff Furniture knob

Art.-Nr.	Maße in mm							
	A	B	C	D	Ø	Ø	Ø	
8908.01	55	91	75	46	62	2	3x15	20
8908.02	80	106	90	51	73	2	3x15	20

8910 Möbelgriff Furniture knob

Art.-Nr.	Maße in mm						
	A	B	C	Ø	Ø	Ø	
8910.01	45	117	95	27	3	3,5x20	20
8910.02	60	137	115	31	3	3,5x20	20

8912 Ringgriff mit Rosette Ring handle with escutcheon

Art.-Nr.	Maße in mm							
	A	B	C	D	Ø	Ø	Ø	
8912.01	35	24	54	37	15	2	M4x30	20
8912.02	50	28	66	45	18	2	M4x30	20

8914 Möbelknopf Furniture knob

Art.-Nr.	Maße in mm					
	A	B	Ø	Ø	Ø	
8914.01	35	36	28	4	M4x30	20



Modell Rustikal S 900

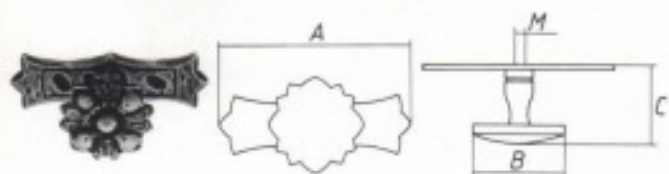

8916 Möbelknopf mit Rosette Furniture knob with escutcheon

Art.-Nr.	Maße in mm						
	A	B	C	Ø	↳	↳	↳
8916.01	50	51	36	30	2	M4x30	20
8916.02	70	90	36	30	2	M4x30	20

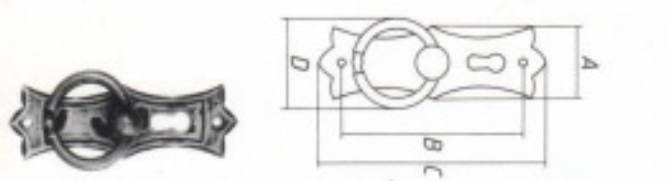

8918 Ringgriff mit Schlüsselschild Ring handle with key plate

Art.-Nr.	Maße in mm						
	A	B	C	D	Ø	↳	↳
8918.01	55	28	75	90	37	2	3x15 20

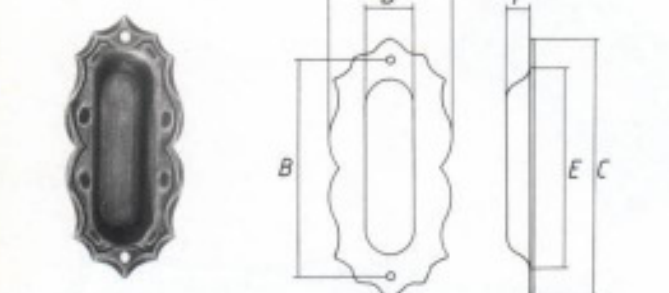

8920 Schiebetürgriff Sliding door handle

Art.-Nr.	Maße in mm						
	A	B	C	D	E	F	Ø
8920.01	50	48	83	99	18	65	9 2 3x15 20

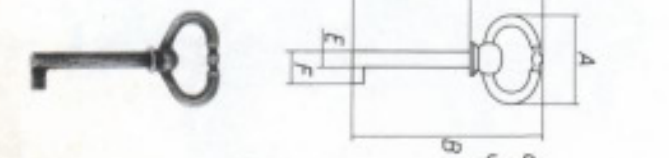

8922 Möbelschlüssel Furniture key

Art.-Nr.	Maße in mm						
	A	B	C	D	E	F	Ø
8922.01	30	35	75	30	45	6	13,5 20

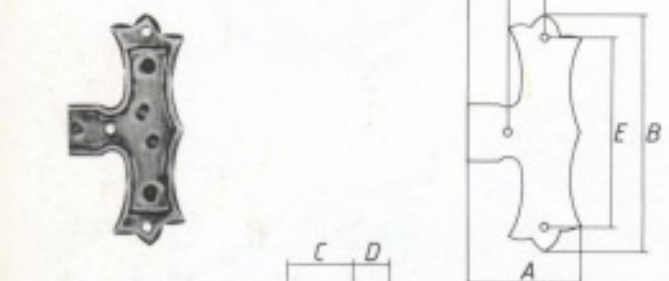

8924 Scheinband Hinge shield

Art.-Nr.	Maße in mm						
	A	B	C	D	E	Ø	↳
8924.01	35	44	90	16	14	76	2 3x15 20
8924.02	50	52	106	20	16	90	2 3x15 20

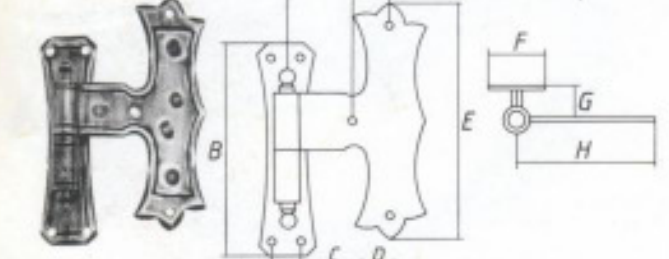

8926 Möbelband mit Aufschraubkegel Hinge shield with plate

Art.-Nr.	Maße in mm								
	A	B	C	D	E	F	G	H	Ø
8926.01	95	14	81	26	14	90	23	13 54	2 3x15 20
8926.02	110	14	81	33	16	106	23	13 65	2 3x15 20

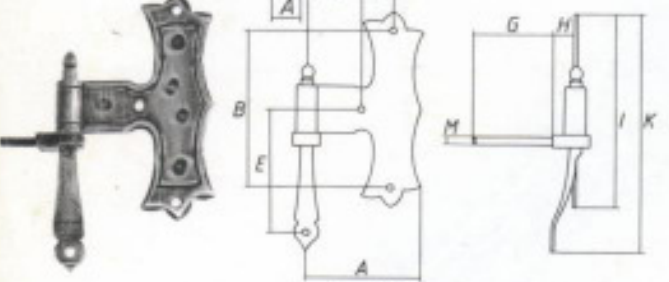

8928 Möbelband mit Stützkegel Hinge shield with support pin

Art.-Nr.	Maße in mm										
	A	B	C	D	E	G	H	I	K	Ø	↳
8928.01	75	54	76	26	14	57	37	11	90	110	2 3x15 M4x3,5 20
8928.02	90	65	90	33	16	59	37	11	106	114	2 3x15 M4x3,5 20

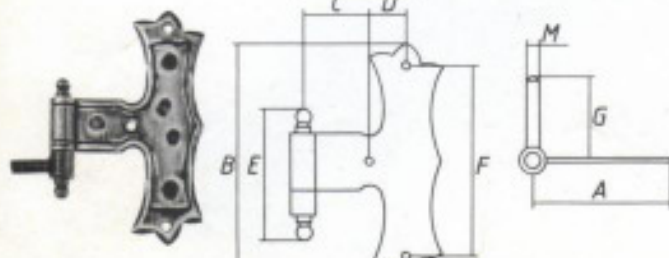

8930 Möbelband mit Einbohrkegel Hinge shield with bolt hole

Art.-Nr.	Maße in mm									
	A	B	C	D	E	F	G	Ø	↳	M
8930.01	65	54	90	26	14	46	76	32	2 3x15	S6x0,9 20
8930.02	80	65	106	33	16	50	90	32	2 3x15	S6x0,9 20



Modell Rustikal S 900

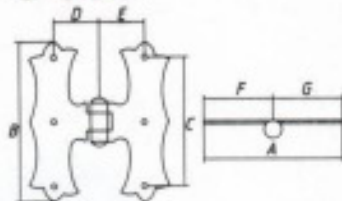

8932 Doppelscharnier Double hinge frame

Art.-Nr.	Maße in mm								↺	↻	⊕
	A	B	C	D	E	F	G				
8932.02	105	87	106	90	27	27	43,5	43,5	2	3x15	10
8932.03	360	137	170	140	44	44	68,5	68,5	3	4x20	10

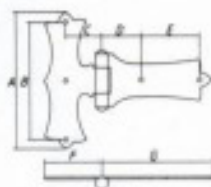

8934 Doppelscharnier Double hinge frame

Art.-Nr.	Maße in mm								↺	↻	⊕
	A	B	C	D	E	F	G				
8934.01	105	106	90	28	31	45	44	87	2	3x15	10
8934.02	320	170	141	45	43	66	69	125	3	4x20	10

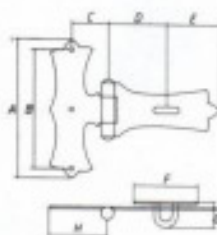

8936 Überfalle mit Schlaufe Chest hinge

Art.-Nr.	Maße in mm								↺	↻	⊕	
	A	B	C	D	E	F	G	H				
8936.01	120	106	90	28	45	42	40	20	44	2	3x15	10
8936.02	330	170	141	45	60	66	46	27	69	3	4x20	10

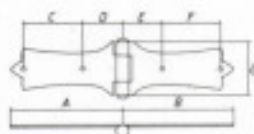

8938 Doppelscharnier Double hinge frame

Art.-Nr.	Maße in mm								↺	↻	⊕
	A	B	C	D	E	F	G				
8938.01	100	87	87	45	31	31	45	40	2	3x15	10
8938.02	300	120	120	66	43	43	66	42	3	4x20	10

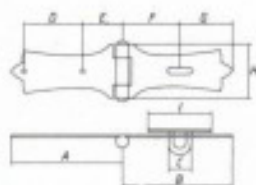

8940 Überfalle mit Schlaufe Chest hinge

Art.-Nr.	Maße in mm									↺	↻	⊕	
	A	B	C	D	E	F	G	H	I				
8940.01	115	87	87	19	45	31	45	42	40	40	2	3x15	10
8940.02	320	120	120	23	66	43	60	66	42	46	3	4x20	10



8942 Truhengriff Chest handle

Art.-Nr.	Maße in mm					↺	↻	⊕
	A	B	C	D				
8942.01	260	240	204	36	50	5	4x20	10

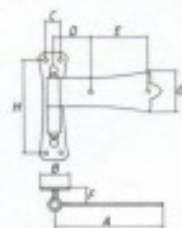

8944 Klobenband mit Kegel Hinge

Art.-Nr.	Maße in mm								↺	↻	⊕	
	A	B	C	D	E	F	G	H				
8944.01	85	85	23	14	30	45	13	32	70	2	3x15	10

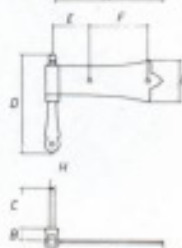

8946 Klobenband mit Kegel Hinge

Art.-Nr.	Maße in mm								↺	↻	⊕	
	A	B	C	D	E	F	G	H				
8946.01	85	85	12	40	85	30	45	32	M4	2	3x15	10

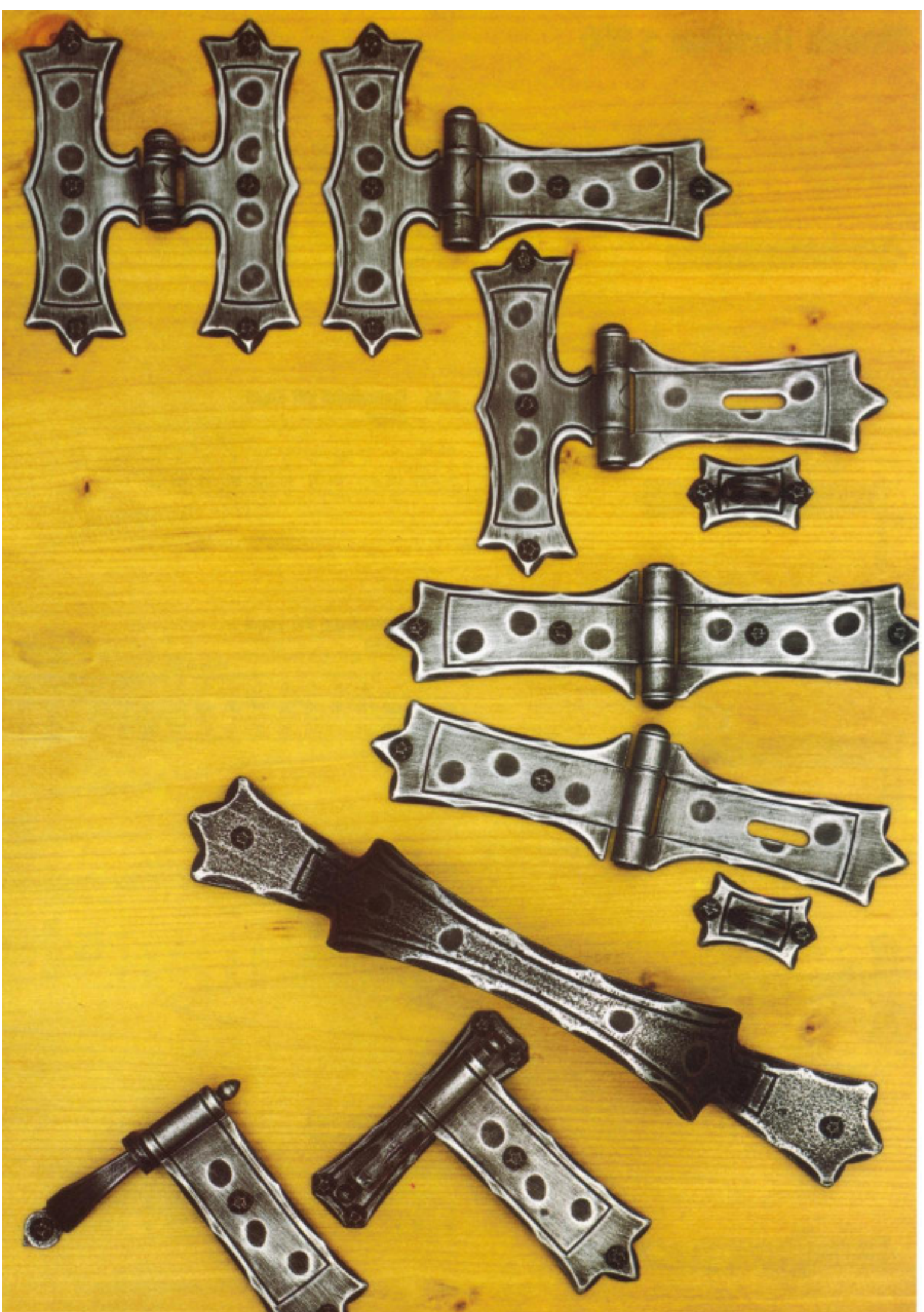

Modell Rustikal S 900

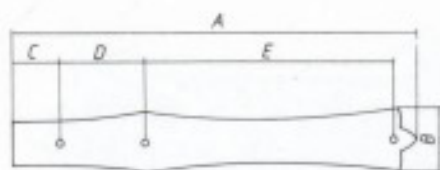

8948 Scheinband Hinge shield

Art.-Nr.	Maße in mm								↗	↘	⊕
	A	B	C	D	E						
8948.01	100	240	36	28	45	134	2	3x15	10		
8948.02	36	310	48	50	62	200	3	4x20	10		

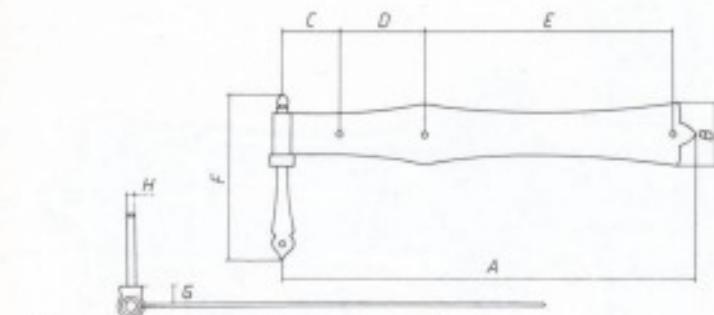

8950 Klobenband mit Kegel Hinge

Art.-Nr.	Maße in mm										↗	↘	⊕	
	A	B	C	D	E	F	G	H						
8950.01	145	221	36	30	45	135	85	10	M4	2	4x20	10		

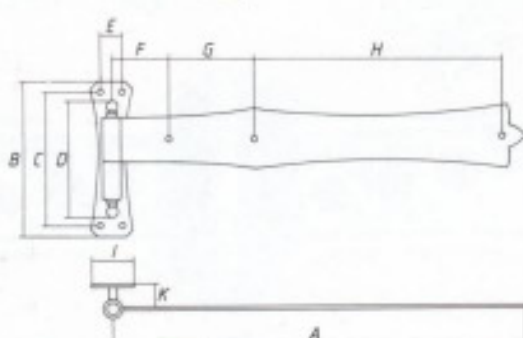

8952 Klobenband mit Kegel Hinge

Art.-Nr.	Maße in mm												↗	↘	⊕	
	A	B	C	D	E	F	G	H	I	K						
8952.01	150	221	81	70	58	14	30	45	135	23	13	2	4x20	10		
8952.02	580	348	120	88	92	16	65	62	202	33	25	3	4x20	10		

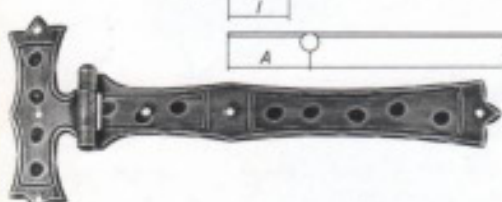
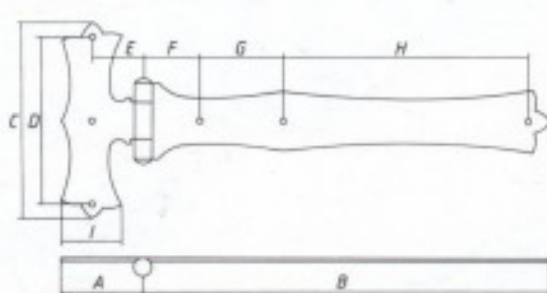

8954 Scharnierband Hinge band

Art.-Nr.	Maße in mm											↗	↘	⊕	
	A	B	C	D	E	F	G	H	I						
8954.01	170	44	224	106	90	28	30	45	135	32	2	4x20	10		
8954.02	510	69	331	170	141	45	48	63	202	48	3		10		

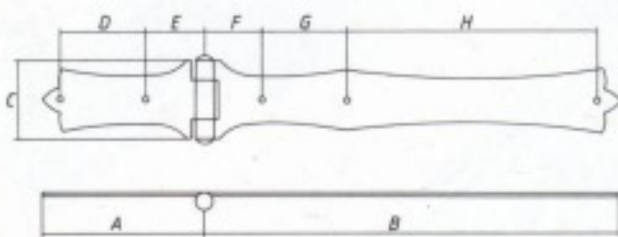

8956 Truhenband Chest hinge

Art.-Nr.	Maße in mm										↗	↘	⊕	
	A	B	C	D	E	F	G	H						
8956.01	170	87	224	40	45	31	30	45	135	2	4x20	10		
8956.02	510	125	331	42	66	43	48	63	202	3	4x20	10		





**8788 Rosette
Escutcheon**

Art.-Nr.	Maße in mm					
	A	B	C			
8788.00	40	97	75	36	2	3x15 20

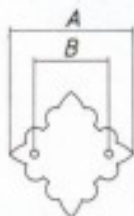

**8792 Rosette
Escutcheon**

Art.-Nr.	Maße in mm					
	A	B				
8792.00	15	50	28	2	3x15 20	

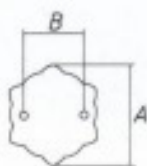

**8609 Rosette
Escutcheon**

Art.-Nr.	Maße in mm					
	A	B				
8609.00	15	51	7	2	20	



**8846 Rosette
Escutcheon**

Art.-Nr.	Maße in mm					
	A	B				
8846.00	10	32	5	1,5	20	



**8766 Rosette
Escutcheon**

Art.-Nr.	Maße in mm					
	A	B				
8766.00	15	40	25	2	3x15 20	

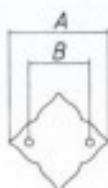

**8803 Rosette
Escutcheon**

Art.-Nr.	Maße in mm					
	A	B				
8803.00	15	40	26	2	3x15 20	

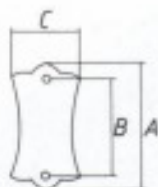

**8904 Rosette
Escutcheon**

Art.-Nr.	Maße in mm					
	A	B	C			
8904.00	10	40	30	24	2	3x15 20

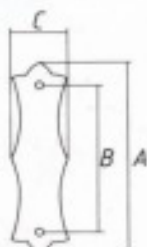

**8900 Rosette
Escutcheon**

Art.-Nr.	Maße in mm					
	A	B	C			
8900.00	20	77	60	24	2	3x15 20

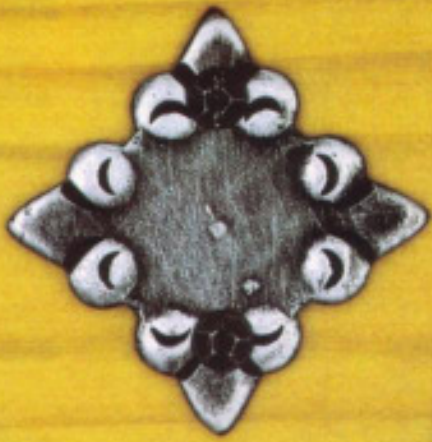

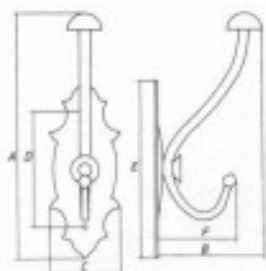

**8630 Huthaken
Hat hook**

Art.-Nr.	Maße in mm							↗	↘	⊘
	A	B	C	D	E	F				
8630.01	180	185	100	52	85	137	55	2	3,5x20	10

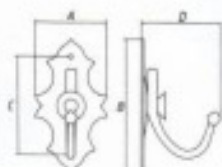

**8636 Mantelhaken
Coat hook**

Art.-Nr.	Maße in mm					↗	↘	⊘
	A	B	C	D	E			
8636.11	105	56	101	76	51	2	3,5x20	10

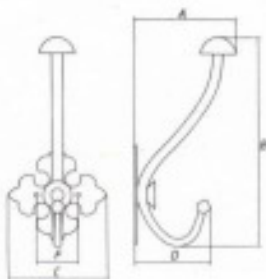

**8633 Huthaken
Hat hook**

Art.-Nr.	Maße in mm						↗	↘	⊘
	A	B	C	D	F	E			
8633.01	150	100	160	76	55	31	2	3,5x20	10

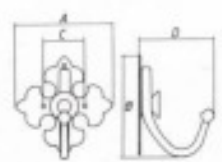

**8636 Mantelhaken
Coat hook**

Art.-Nr.	Maße in mm					↗	↘	⊘
	A	B	C	D	E			
8636.01	90	76	80	31	55	2	3,5x20	10

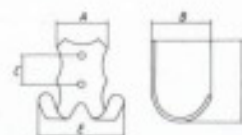

**8632 Mantelhaken
Coat hook**

Art.-Nr.	Maße in mm					↗	↘	⊘	
	A	B	C	D	E				
8632.01	170	109	59	49	168	36	3	3,5x20	10

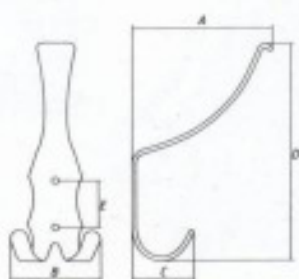

**8632 Huthaken
Hat hook**

Art.-Nr.	Maße in mm					↗	↘	⊘	
	A	B	C	D	E				
8632.02	65	39	48	19	62	57	3	3,5x20	10





8634 Huthaken Hat hook

Art.-Nr.	Maße in mm								
		A	B	C	D	E			
8634.01	340	75	220	74	34	46	7	4x20	10

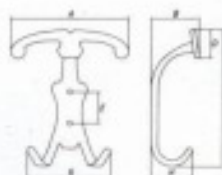

8634 Huthaken Hat hook

Art.-Nr.	Maße in mm									
		A	B	C	D	E	H	G		
8634.02	320	128	55	152	30	34	46	74	7	4x20 10



8634 Mantelhaken Coat hook

Art.-Nr.	Maße in mm							
		A	B	C	D	E	F	
8634.03	175	72	100	39	34	7	43	10

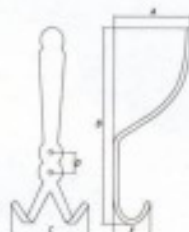

8635 Huthaken Hat hook

Art.-Nr.	Maße in mm							
		A	B	C	D	E		
8635.01	235	85	210	70	20	40	5	3x20 10

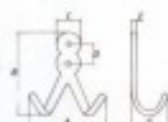

8635 Mantelhaken Coat hook

Art.-Nr.	Maße in mm							
		A	B	C	D	E	G	
8635.02	100	73	85	25	20	5	42	3x20 10



8639 Haken Hook

Art.-Nr.	Maße in mm						
		A	B	C	D		
8639.01	20	18	56	14	33	3	3,5x20 20
8639.02	25	19	61	20	44	3	3,5x20 20



8818 Haken Hook

Art.-Nr.	Maße in mm						
		A	B	C	D		
8818.01	10	28	49	14	14	2	3x15 20
8818.02	15	35	63	14	18	2	3x15 20
8818.03	20	40	73	20	20	2	3x15 20



8810 Deckenhaken Ceiling hook

Art.-Nr.	Maße in mm						
		A	B	C	D	E	M
8810.01	45	58	70	32	35	30	2 Ø4x35 20
8810.02	75	65	91	38	51	43	2 Ø6x40 20



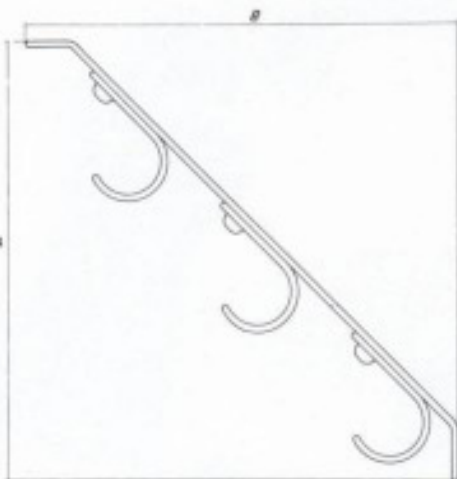

**8820 Schrägarm ohne Stütze
Coat hooks**

Art.-Nr.	Maße in mm				
		A	B		
8820.01	720	410	270	4	2

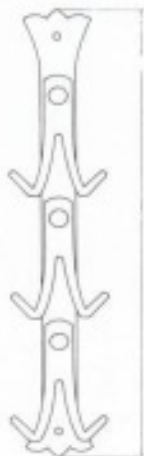

**8821 Schrägarm mit Stütze
Coat hooks**

Art.-Nr.	Maße in mm				
		A	B		
8821.01	560	280	290	4	2

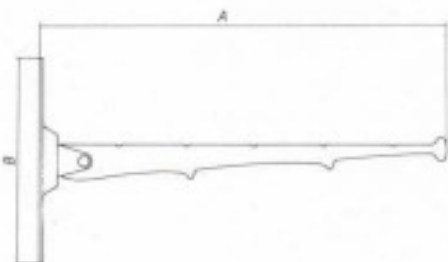

**8819 Klapphaken
Folding hook**

Art.-Nr.	Maße in mm					
		A	B			
8819.27	310	270	135	6	4x20	10

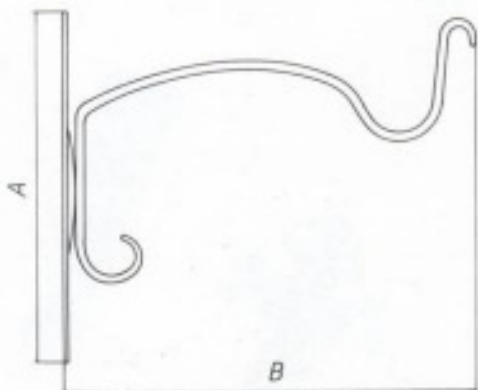

**8819 Träger
Carrier**

Art.-Nr.	Maße in mm					
		A	B			
8819.30	190	140	105	4	4x20	10
8819.40	240	140	210	5	4x20	10



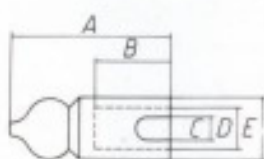

8682 Zierhülsen Decorative sleeve

Art.-Nr.	Maße in mm						⊗
	A	B	C	D	E		
8682.01	20	30	14	5	9	12	20
8682.02	30	36	16	6	11	14	20
8682.03	40	45	19	8	13	16	20
8682.04	65	48	21	9	16	20	20
8682.05	90	55	23	10	18	22	20

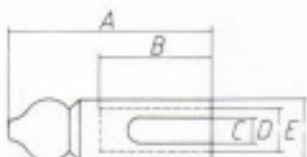

8682 Zierhülsen Decorative sleeve

Art.-Nr.	Maße in mm						⊗
	A	B	C	D	E		
8682.11	25	42	26	6	9	12	20
8682.12	35	47	27	6	11	14	20
8682.13	50	57	32	7	13	16	20
8682.14	75	61	36	9	16	20	20
8682.15	100	71	40	9	18	22	20

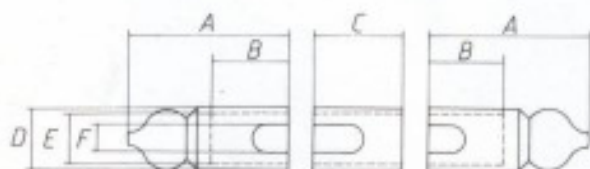

8682 Zierhülsen Decorative sleeve

Art.-Nr.	Maße in mm							⊗
	A	B	C	D	E	F		
8682.54	130	42	16	30	20	16	8	20
8682.56	180	53	21	46	23	20	10	20
8682.57	280	59	24	49	26	22	12	20

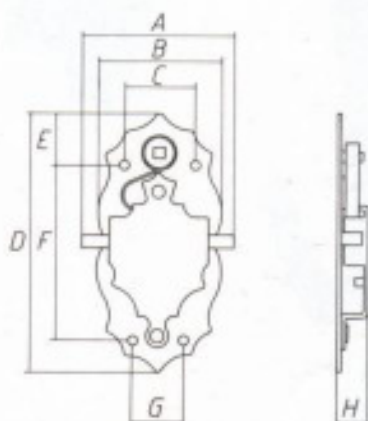

8957 Möbelschloß Furniture lock

Art.-Nr.	Maße in mm											
	A	B	C	D	E	F	G	H	↔	⊗		
8957.01	120	60	48	28	100	21	67	20	13	1,5	3x15	10

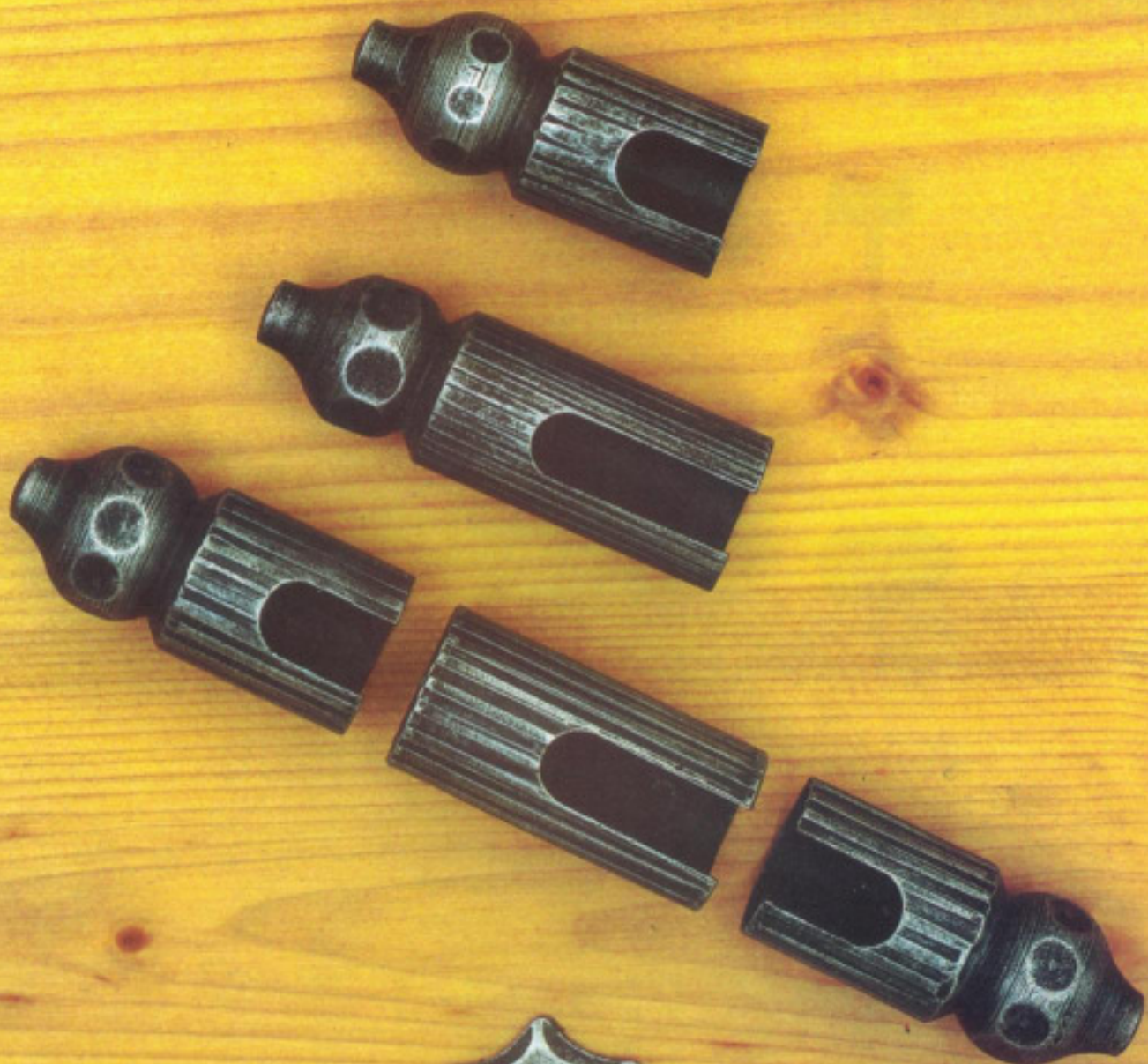

Ziernägel geschmiedet

Ornamental nails forged



8700 Ziernägel Ornamental nail

Art.-Nr.	Maße in mm			
	Kopfgröße	Stiftlänge	→	↻
8700.01	16x16	22-25	10	100
8700.02	20x20	22-25	15	100



8704 Ziernägel Ornamental nail

Art.-Nr.	Maße in mm			
	Kopfgröße	Stiftlänge	→	↻
8704.01	Ø 25 ¹⁶	22-25	15	100
8704.02	Ø 25 ¹⁹	22-25	15	100
8704.03	Ø 25	22-25	15	100



8717 Ziernägel Ornamental nail

Art.-Nr.	Maße in mm			
	Kopfgröße	Stiftlänge	→	↻
8717.01	Ø 13	10	1,5	100
8717.02	Ø 19	10	1,5	100
8717.03	Ø 25	12	1,5	100



8718 Ziernägel Ornamental nail

Art.-Nr.	Maße in mm			
	Kopfgröße	Stiftlänge	→	↻
8718.01	Ø 25	16	5	100
8718.02	Ø 18	16	5	100

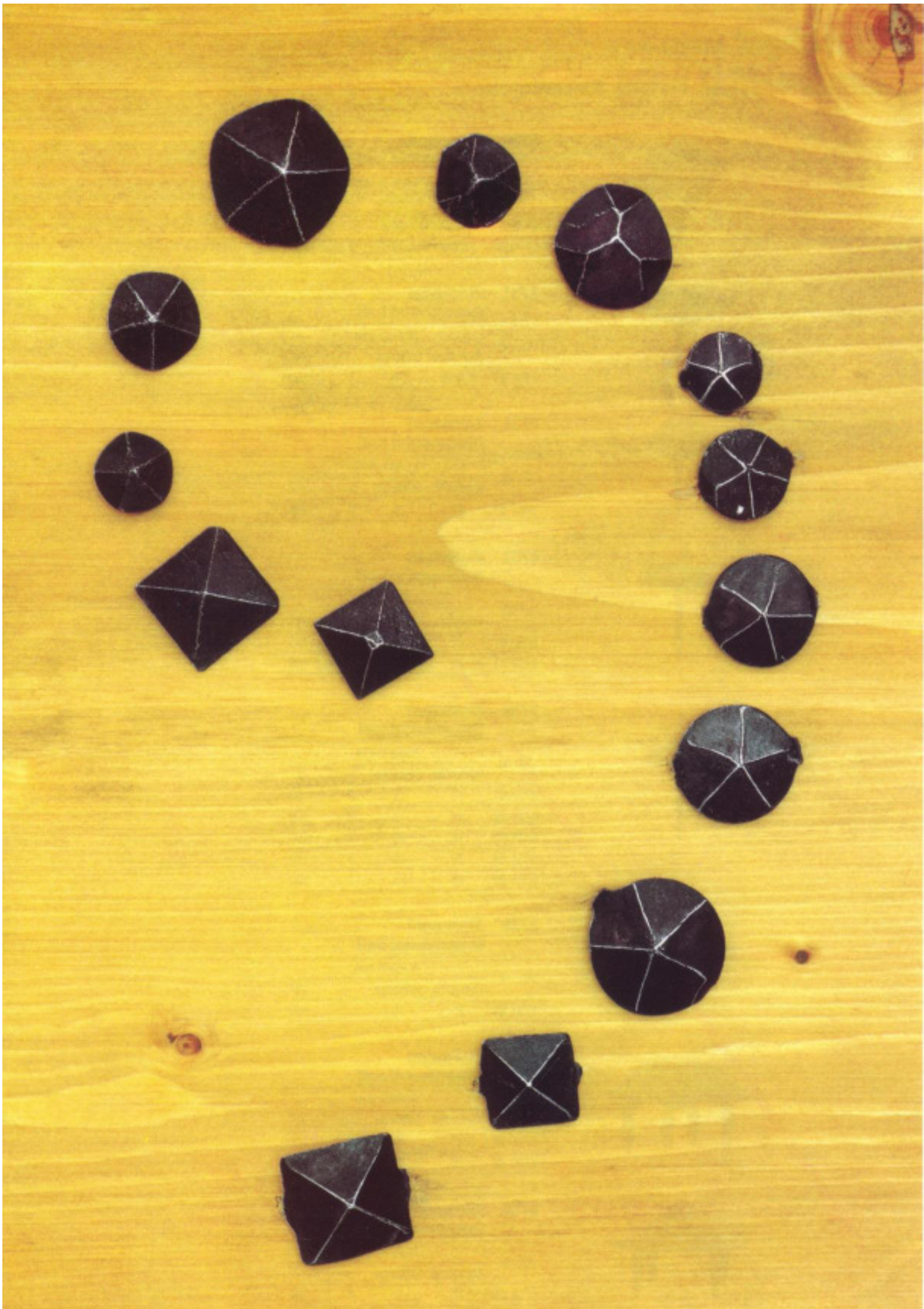



Ziernägel Zink-Druckguß



Ornamental nails Die-casting-zinc





8730 Ziernagel Ornamental nail

Art.-Nr.	Maße in mm			
	Kopfgröße	Stiftlänge		
8730.01	14x14	20	4	100
8730.02	18x18	20	7	100



8731 Ziernagel Ornamental nail

Art.-Nr.	Maße in mm			
	Kopfgröße	Stiftlänge		
8731.01	20x20	20	7	100

8732 Ziernagel Ornamental nail

Art.-Nr.	Maße in mm			
	Kopfgröße	Stiftlänge		
8732.01	22	25	9	100

8733 Ziernagel Ornamental nail

Art.-Nr.	Maße in mm			
	Kopfgröße	Stiftlänge		
8733.01	22	25	6	100
8733.02	25	25	6	100



8734 Ziernagel Ornamental nail

Art.-Nr.	Maße in mm			
	Kopfgröße	Stiftlänge		
8734.01	10	15	2	100
8734.02	14	15	2	100
8734.03	16	20	3	100
8734.04	20	20	7	100
8734.05	25	25	11	100



8734 Ziernagel Ornamental nail

Art.-Nr.	Maße in mm		
	Kopfgröße	Stiftlänge	
8734.55	25	15	100

8735 Ziernagel Ornamental nail

Art.-Nr.	Maße in mm			
	Kopfgröße	Stiftlänge		
8735.01	22	6	4	100
8700.02	26	6	4	100

8736 Ziernagel Ornamental nail

Art.-Nr.	Maße in mm			
	Kopfgröße	Stiftlänge		
8736.01	25	5	4	100

Achtung: Zur Zeit nicht lieferbar!

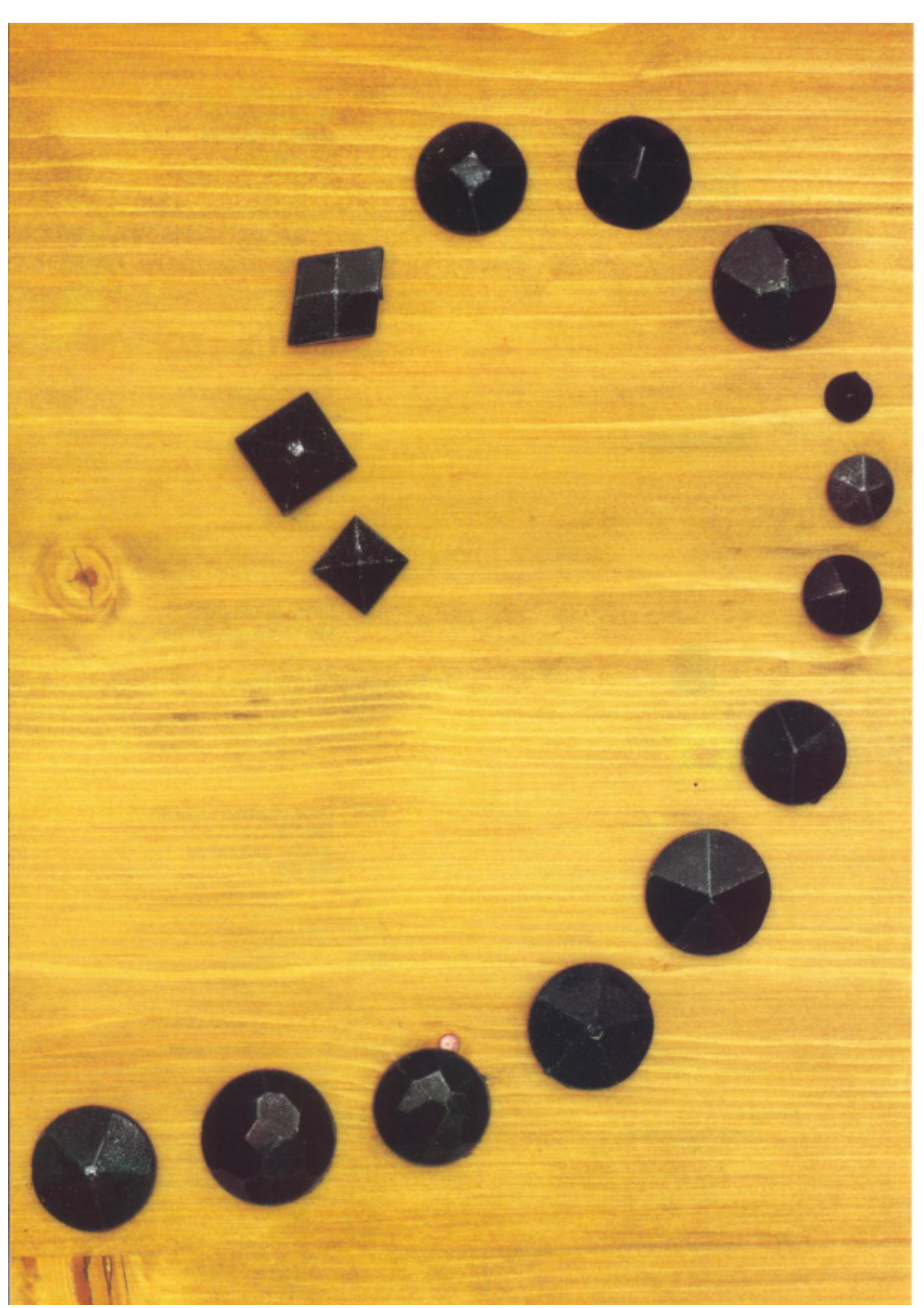



8684 Zierkopf-Holzschraube
Wood screw with
ornamental head

Art.-Nr.	Maße in mm
	Größe/size
8684.01	3x15
8684.02	3,5x20
8684.03	4x20
8684.04	4x30



8686 Linsen-Senkschraube
DIN 964
Oval flat head screw
DIN 964

Art.-Nr.	Maße in mm
	Größe/size
8686.01	M 4 x 30
8686.02	M 4 x 40
8686.03	M 6 x 50



8688 Hutmutter verzinkt
cap screw galvanised

Art.-Nr.	Maße in mm
	Größe/size
8688.01	M 4
8688.02	M 6



8690 Beilagscheibe verzinkt
DIN 125
washer galvanised
DIN 125

Art.-Nr.	Maße in mm
	Größe/size
8690.01	für Gewindestift M4
8690.02	für Gewindestift M6



8691 Gewindestift verzinkt
DIN 551
threaded pin
galvanised DIN 551

Art.-Nr.	Maße in mm
	Größe/size
8691.01	M 4 x 30
8691.02	M 4 x 35
8691.03	M 4 x 40
8691.04	M 6 x 35

VERKAUFSBEDINGUNGEN:

Für alle Verkäufe gelten die nachstehenden Bedingungen.
Für Exportlieferungen gelten in Ergänzung bzw. abweichend die Bedingungen des jeweiligen Angebotes.

AUFTRAGSERTEILUNG: Aufträge gelten erst dann als angenommen, wenn sie schriftlich bestätigt sind. Dies gilt auch für an Vertreter erteilte Aufträge. Einmal erteilte Aufträge können nur mit unserem Einverständnis annulliert werden. Lieferbedingungen des Bestellers sind für uns unverbindlich.

SONDERANFERTIGUNGEN: Ein Rücktritt von solchen Aufträgen ist keinesfalls möglich, und wir behalten uns eine Mehr- oder Minderlieferung bis zu 10 Prozent vor.

PREIS: Alle Preise und Angebote sind freibleibend und verstehen sich im allgemeinen frei Bestimmungsstation und einschließlich Verpackung. Die Verpackung wird nicht zurückgenommen. Bei Postpaketsendungen unter einem Mindestwert, der in der jeweils gültigen Preisliste festgelegt erscheint, werden Porto und Verpackung in Rechnung gestellt.

VERSAND: Der Versand erfolgt immer auf Gefahr des Käufers. Postexpress- oder Bahnexpresskosten werden voll berechnet oder die Sendungen werden unfrei abgefertigt.

LIEFERZEIT: Lieferzeitangaben sind stets annähernd zu betrachten und für uns unverbindlich. Darüber hinaus entbinden uns Fälle höherer Gewalt von jeder Verpflichtung. Schadenersatzansprüche wegen Lieferverzögerungen können an uns nicht gestellt werden.

ZAHLUNGSKONDITIONEN: Die Bezahlung unserer Rechnung kann innerhalb von 14 Tagen ab Rechnungsdatum abzüglich 2 Prozent Skonto oder innerhalb von 30 Tagen netto erfolgen, es sei denn, daß wir bei Auftragserteilung andere Zahlungsbedingungen stellen.

Bei Zahlungsverzögerungen werden Verzugszinsen in der Höhe von 2 Prozent über der jeweiligen Nationalbankrate berechnet. Zahlungen an unsere Vertreter dürfen nur gegen Vorweis unserer Inkassovollmacht erfolgen. Wenn sich die der Kreditgewährung zugrunde gelegten Verhältnisse ändern, sind wir berechtigt, die Zahlungsbedingungen neu festzulegen.

MÄNGELRÜGEN: Beanstandungen irgendwelcher Art können nur dann berücksichtigt werden, wenn solche spätestens innerhalb von 8 Tagen nach Warenerhalt angebracht werden.

ABBILDUNGEN, GEWICHTSANGABEN UND MASSE: Alle Abbildungen und Gewichtsangaben in diesem Katalog sind nicht verbindlich, weil wir laufend an Verbesserungen arbeiten.

EIGENTUMSVORBEHALT: Die gelieferte Ware verbleibt bis zur vollständigen Bezahlung unser Eigentum. Wechsel oder Schecks gelten erst nach ihrer Einlösung als Bezahlung. Die Ware darf weiters weder verließen, beliehen oder verpfändet werden. Wir sind jederzeit berechtigt, die Rückgabe der uns gehörenden Waren zu verlangen. Im Falle eines Konkurses steht uns das gesetzliche Aussonderungsrecht zu, auch Dritten gegenüber.

GARANTIE: WIR LEISTEN FÜR JEDES STÜCK, DAS MIT UNSERER MARKE »HALCO« VERSEHEN IST, GARANTIE BEI MATERIAL- UND FABRIKATIONSFEHLERN. Fehlerhafte Waren werden entweder einwandfrei repariert oder kostenlos ersetzt, wenn sie franko an uns zur Überprüfung geschickt werden. Darüber hinausgehende Ansprüche können nicht geltend gemacht werden, auch für natürlichen Verschleiß und für durch unvorsichtige Behandlung verdorbene Werkzeuge wird kein Ersatz geleistet.

GERICHTSSTAND: Als Gerichtsstand gilt Innsbruck für beide Teile als vereinbart.

TERMS AND CONDITIONS:

All our sales are subject to the following terms and conditions. Export sales are made under special conditions mentioned in the respective order.

ORDERS: All orders are accepted by written order confirmation only. The same is true for orders which have been given to representatives. Cancellation of orders placed with our agreement only. Terms stated by the buyer are without obligation for us.

SPECIAL MAKES: Withdrawal of such orders is not possible and we reserve the right to deliver with a tolerance in quantity of plus/minus 10%.

PRICES: All prices and offers are without engagement, terms of freight according to confirmation of order.

DELIVERY: Deliveries are always for buyers' risk. For express deliveries either by post or train costs will be charged.

TIME OF DELIVERY: Time of delivery is always approximate and without obligation. No obligations in cases of force majeure. We shall not accept claims resulting from delayed shipments.

TERMS OF PAYMENT: Our normal terms are "2% discount on payment within 14 days from date of invoice or 30 days net". For delayed payments we shall charge 2% interests above the official bank rate.

CLAIMS ON QUALITY: Complaints can be accepted only within 8 days after receipt of goods.

ILLUSTRATIONS AND WEIGHTS: All illustrations and weights shown in this catalogue are stated without obligations as we work steadily on improvements.

PROPERTY RESERVATION: Delivered goods remain our property until full settlement of invoice. Drafts and or cheques are to be understood as settled after honouring. Goods can neither be hired out, nor loaned on, nor put in pledge. We reserve the right to have, our property goods sent back. In case of bankruptcy we reserve the right of legal separation.

GUARANTEE: All our articles are stamped with our Trade Mark »HALCO«. They are fully guaranteed against defective material of faulty workmanship. Defective articles will be replaced or repaired. Claims should be sent direct to us together with the defective article. No other claims can be accepted.

COMPETENCY: Legal claims are to be put the competency of the civil court at Innsbruck.

halco



**WERKZEUG
ERSTER QUALITÄT
TOOLS
TOP QUALITY**

Alfred Hörtnagl KG
A-6166 Fulpmes
Tel. 05225/2670 und 2230
Telex 05-3258 alhoe



Ihr halco Fachhändler Your halco dealer